

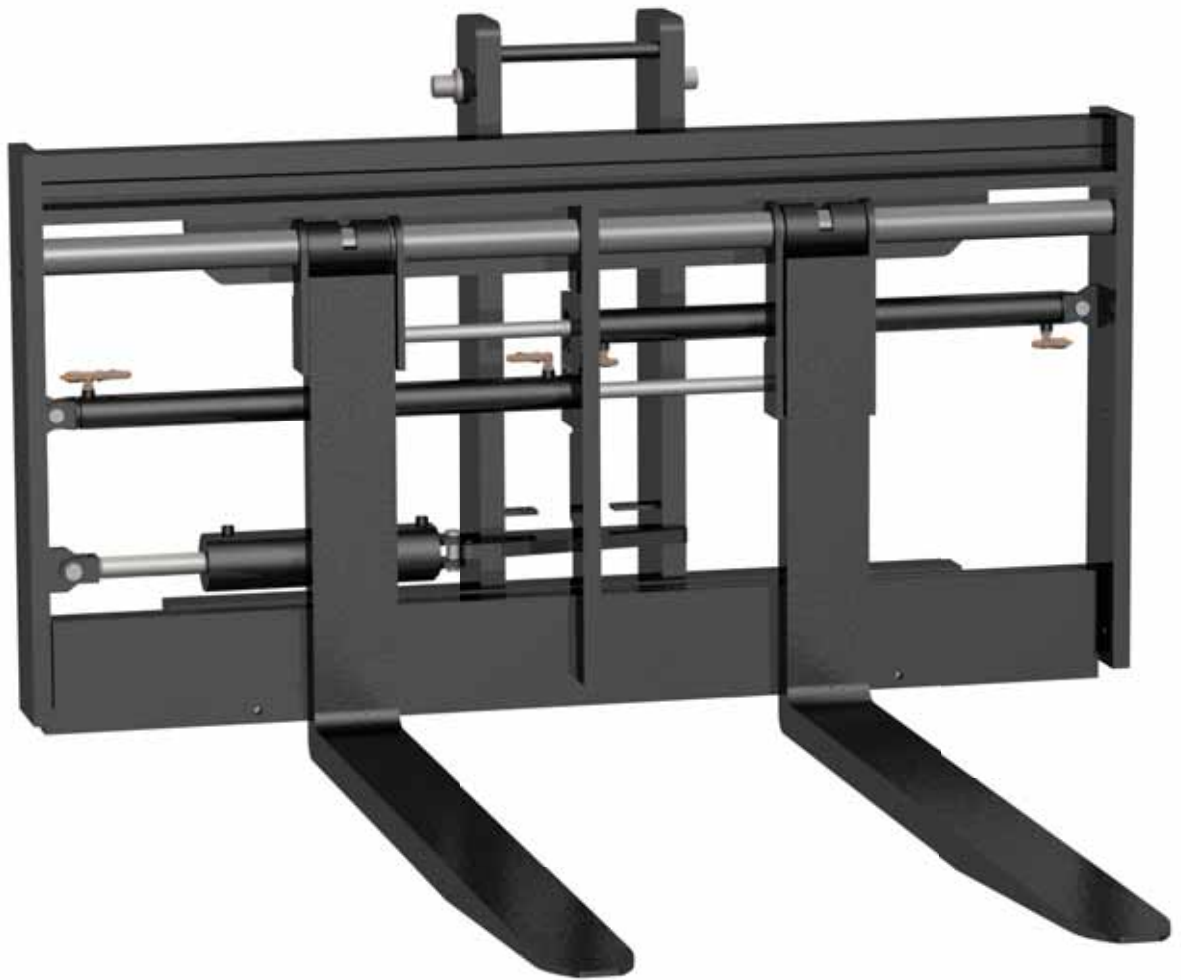

Additional Functionality For Your Lift Truck



Increased visibility and less lost load for faster and more efficient handling.

Cascade provides a rugged line of integral carriages that provide more functionality for your lift truck with significant gains in net capacity over hang on versions.

Hardened high strength fork pins for long service life

Cross-port relief on fork positioner versions protects components and prevents clamping

Open frame design allows maximum visibility

Self lubricating, long service life bearings

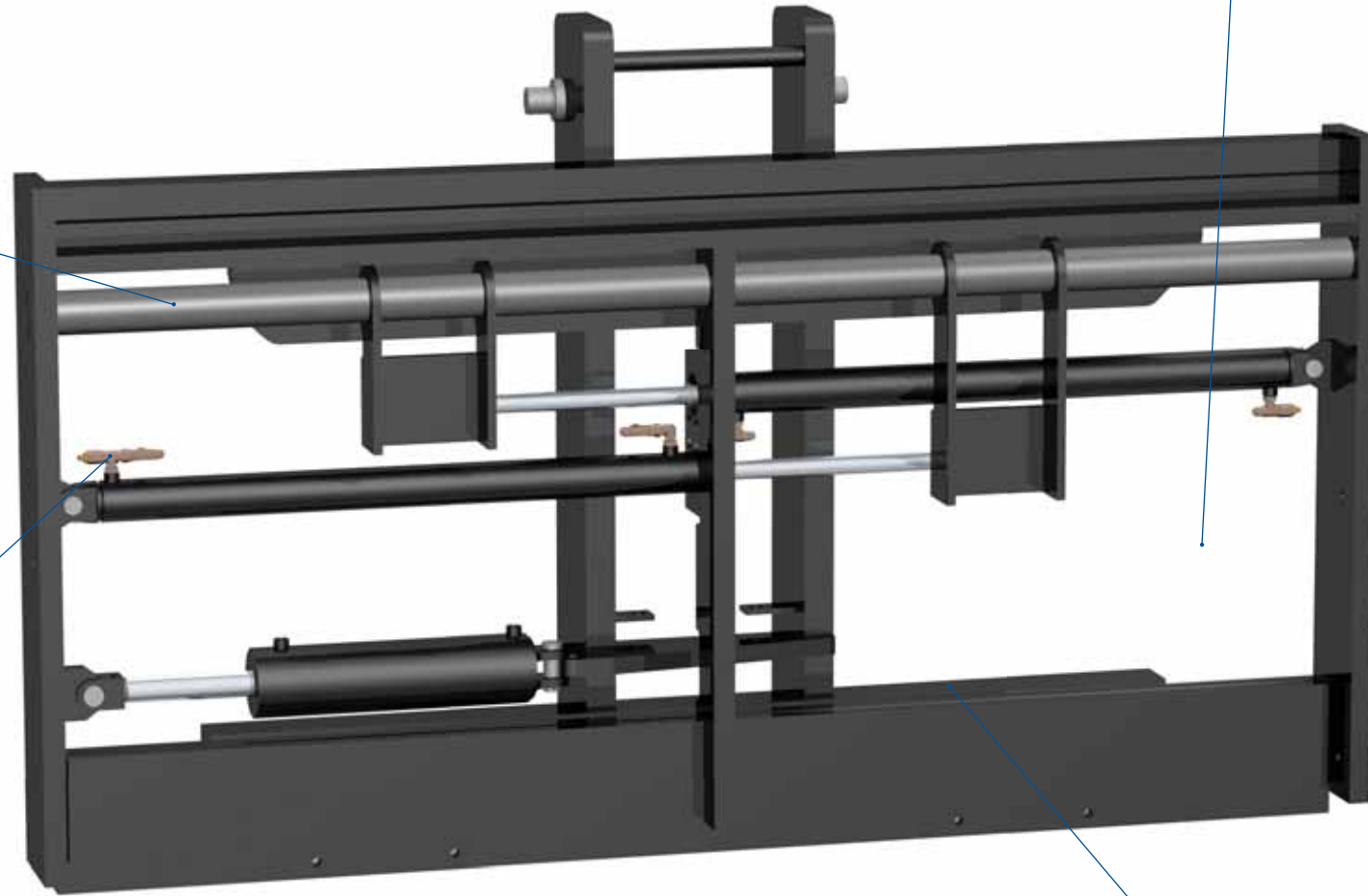

Sideshifting Fork Positioner with Load Hold-Down



Sideshifting Fork Positioning Gypsum Handler



Sideshifting with additional forks



Integral sideshifting fork positioner with bar arm ram



Features

OEM Compatible

- Stubshafts, chain anchors, internal reeving connections compatible with OEM. Uses OEM profile forks if applicable.

Easy Installation

- Install just like you would an OEM carriage. Forks positioned using carriers so no welding of forks is required.

Serviceability

- Cylinders can be removed for service without removing forks or frame.

Custom Designs

- Custom designs available for your specific applications such as slope - used for unloading trucks outside or swing - to allow for alignment

Fork Mounting

- Both pin-type and ITA versions available. Pin-type design allows use of long forks without special options or modifications. Integral allows use of pin-type forks on trucks which only have ITA carriages from OEM.

Capacity

- J-Series Integrals are available with capacities from 8,000 lbs to 36,000 lbs. and larger or smaller capacities are available upon request.

Forks

- Available with all types of forks. Gypsum handling, Lumber and Plywood, Coil handling and special application forks.

Multiple Sideshift Strokes

- Fully customizable integrals to accommodate the total amount of sideshift stroke your application requires.

Fast and Easy Mounting

- All Cascade Integral Sideshifters are shipped ready to install. No welding, drilling or tapping required.

High Net Capacity

- Excellent specifications optimize truck capacity.

Quick Serviceability

- Cylinder is removable for service without removing outer frame. Cylinder rod seals are easily serviced.

Reduced Effective Thickness

- In some applications Integral attachments offer less effective thickness when compared to a hang-on sideshifter or fork positioner.

Variable Widths

- Available in widths both wider and narrower than OEM carriages. Design allows for very wide frames.

A complete selection of carriage designs provide the versatility for any application.

If you have a special handling application let us know. Our designs are flexible and we're always ready to work with you.

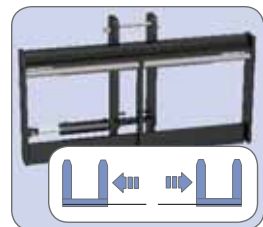

Sideshifting

A rugged hydraulic cylinder anchored to the integral carriage frame moves the sideshifting carriage for precise positioning of loads from side to side.

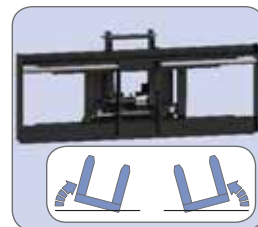

Swingshifting

Used for accurately positioning the loads accurately at an angle to the direction of the truck travel. This model swings the carriage forward and back 10°-20° around the vertical axis.

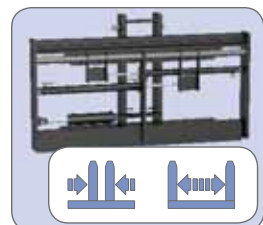

Fork Positioning

Hydraulically actuated fork carriers allow the driver to independently or simultaneously obtain the best fork placement for efficient load engagement. Especially useful on large capacity lift trucks where forks are too heavy to move manually.

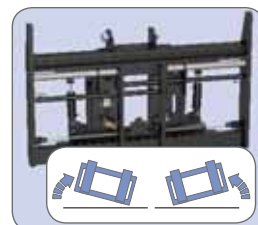

Slope Piling

Used to position loads on uneven surfaces the Slope Piling Carriage provides 10°-20° of an up and down rotation on a horizontal axis.

Increased ability, superior durability.

Whatever the application, we can handle it.

Cascade's J-Series Integral Carriages are so versatile they are used across many industries in various settings. If you have an integral attachment need we'll be there with a solution.



- Food Producing Industry
- Pre-Stressed Concrete
- Mining Industry
- Recycling Industry
- Gypsum Handling
- Lumber Industry
- Foundry Industry
- Automotive Industry
- Military Applications
- Aluminum Industry
- Concrete Pipe Industry
- Stevedoring Industry

Hosing and Hardware to ensure easy installation of your carriage.

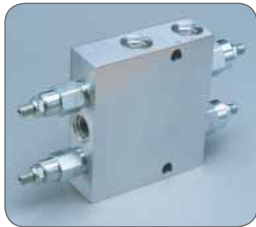

Hydraulic Flow Control Valve With Pressure Relief

Flow control is bidirectional for one hydraulic circuit. Includes one adjustable pressure relief cartridge.



Hose Reel Packages

A practical and economical choice for both new and replacement installations. Cascade's Thinline™ Group package will allow you to achieve the Thinline™ Reel's extremely narrow mounting profile.

*Cascade's engineering department has more experienced engineers than any other company in the industry.
Let their expertise help you.*